

Installation efficiency is 40 times that of mega solar. The power generation costs are almost the same.

Because it does not cause environmental destruction and can be used in snowy regions, become an export industry .

Tree type solar power generation system

Japanese patent: 6656522

The tree-type solar power generation system compensates for the lack of offshore tidal current power generation by wooden artificial islands and water current power generation by setting pools in rivers.

Solar panel unit (both sides)
Plan: 10mx2m:
6 steps in 2 rows

Wire winding motor: 8 pieces

Solar panel unit storage (during strong wind)

Maintenance floor: Plan Φ 13m

In place there is a hatch.

Reinforced concrete foundation: plan \square 2.8m

ladder

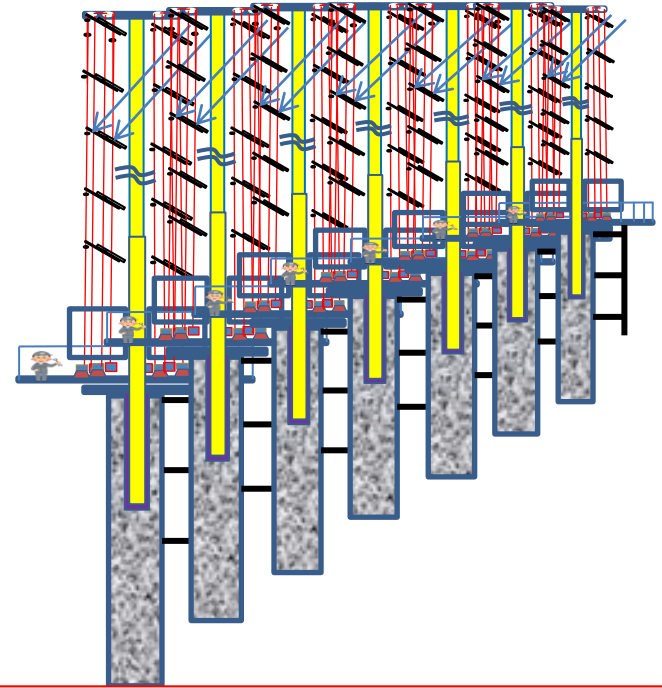

It can be installed in a double row on the border between Ukraine and Russia for both countries, and can be used for both 100% renewable energy and defense. (Great Wall of China)

The tree-type photovoltaic system (Patent No. 6656522) is 40 times more efficient than a mega-solar system in its standard form, has a storage function, can withstand strong winds, and is resistant to snow and sandstorms.

It also coexists with the surrounding nature and existing buildings and does not cause environmental destruction. Furthermore, if it is installed on an artificial wooden island in the ocean, no foundation is required, just fixing it to a wooden frame is sufficient, and the amount of power generated can be expected even at sunrise or sunset (with the reflected light from the sea added).

It comes with an edge computer with a built-in accurate tracking angle program for 365 days. Accurate sunlight tracking is possible automatically by entering the calibration value at the installation site of the built-in radar).

In addition, it is connected to the host computer via the Internet, receives local typhoon, tornado and snowfall information from the host computer, evacuates the solar panel (loosen while folding by loosening the wires), and stores it in the storage box. increase.

With mega-solar power plants, it was difficult in a snowy country, but the slope of the light-receiving panels was wide enough to prevent snow from accumulating. can be dropped.

At first, I was thinking of making it all metal, but I'm thinking of making it all wood, including gears, with the exception of some electric parts such as wires and motors. (Apply liquid glass coating if necessary.)

(Area where the tide does not flow) An artificial wooden island can be set up floating on the sea, it can be installed on the upper side without impairing the function of the road or parking lot, or it can be set up on the mountainside on the south side.

Along the border between Ukraine and Russia, a tree-type solar power generation system whose foundation is made of concrete will be arranged like the Great Wall of China, one for Ukraine and one for Russia. We believe that by relying on electricity from photovoltaic systems, we can protect each other from destruction and intrusion.

Tree type solar power generation system

The edge computer has a sun tracking program installed. At the installation site, enter the longitude and latitude of the installation location.

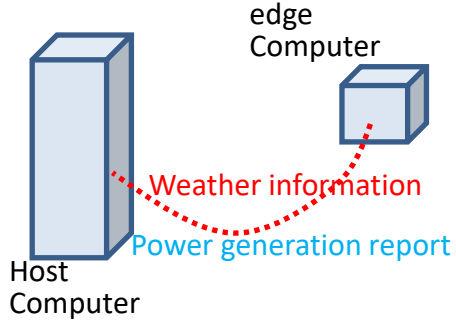

Measure the actual object and read the encoder.

1. due south and horizontal
2. Maximum height position
3. due east and 45 degree angle

Installation efficiency is 40 times that of mega solar.

Connection between wire and panel frame

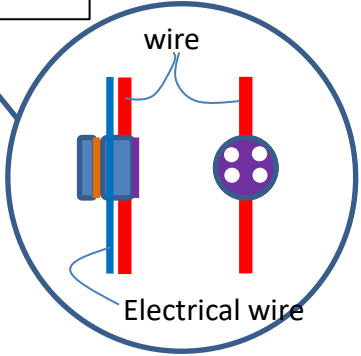

Motor with brake & deceleration when power is off

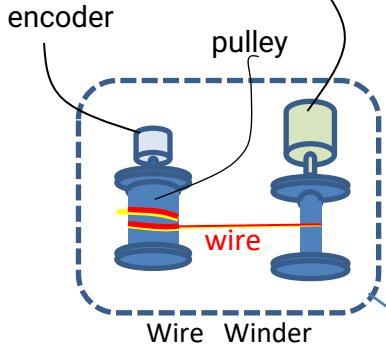

The position of the solar panel is proportional to the number of pulses of the encoder by winding the wire through the pulley attached to the encoder and then winding it with the motor.

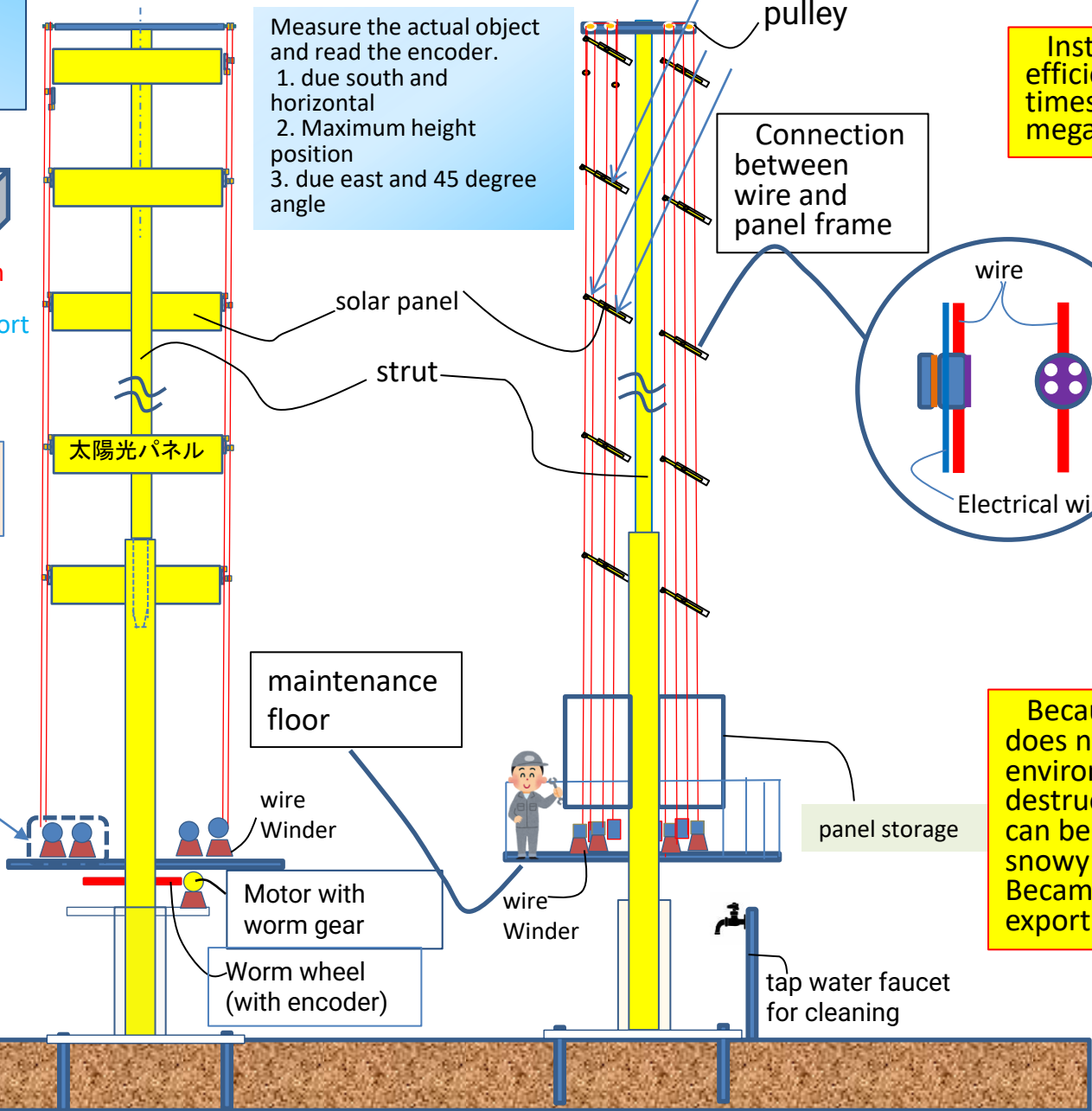

Because it does not cause environmental destruction and can be used in snowy regions, Became an export industry.

Tree type solar power generation system

< safety >

1The anemometer exceeds a certain value Then, ignoring the sun's tracking Level the flannel.

2The wind speed becomes stronger and nears the upper limit of destruction "Tsuku, or things like typhoons According to the previous information, the light receiving panel It automatically descends slowly.

3. Based on advance information such as typhoons, workers can turn on the panel with a remote control.

4. Round off the corners of the light-receiving panel frame to prevent serious injury if it is blown away by a strong wind.

Each unit weighs less than 5 tons (without building a full-fledged road), and each unit is transported by helicopter and assembled on site. Get on the work cargo, remove the guide string, and tighten the screw.

< Panel maintenance procedure >

1. Three qualified workers work. (Elderly people can work.)
2. After lowering all the panels with the remote control, Starting from the top panel, wash in order "Wash at an angle that is easy to use. "
3. One person pours water and the other mops. "Wipe off the dirt with your throat." (One person operates the remote control)

Clean about once a month. If necessary, wash more often in the desert or near the coast. (Non-commercial/residential areas) If it is possible to fly a drone, clean with a spray drone.

Worm wheel with encoder

Carry a small pile driver into the mountain with a helicopter for work.

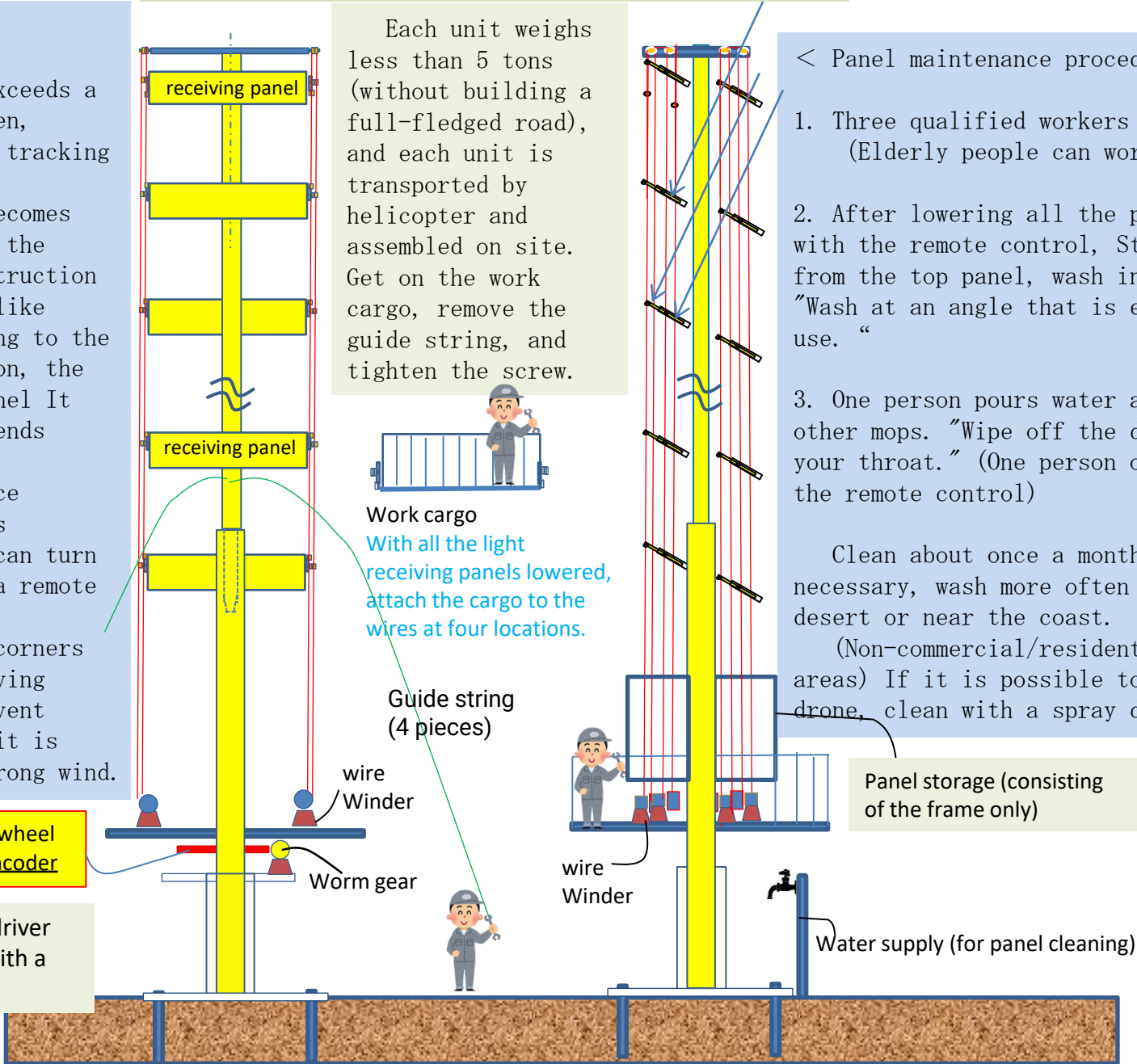

Work cargo
With all the light receiving panels lowered, attach the cargo to the wires at four locations.

Panel storage (consisting of the frame only)

Water supply (for panel cleaning)

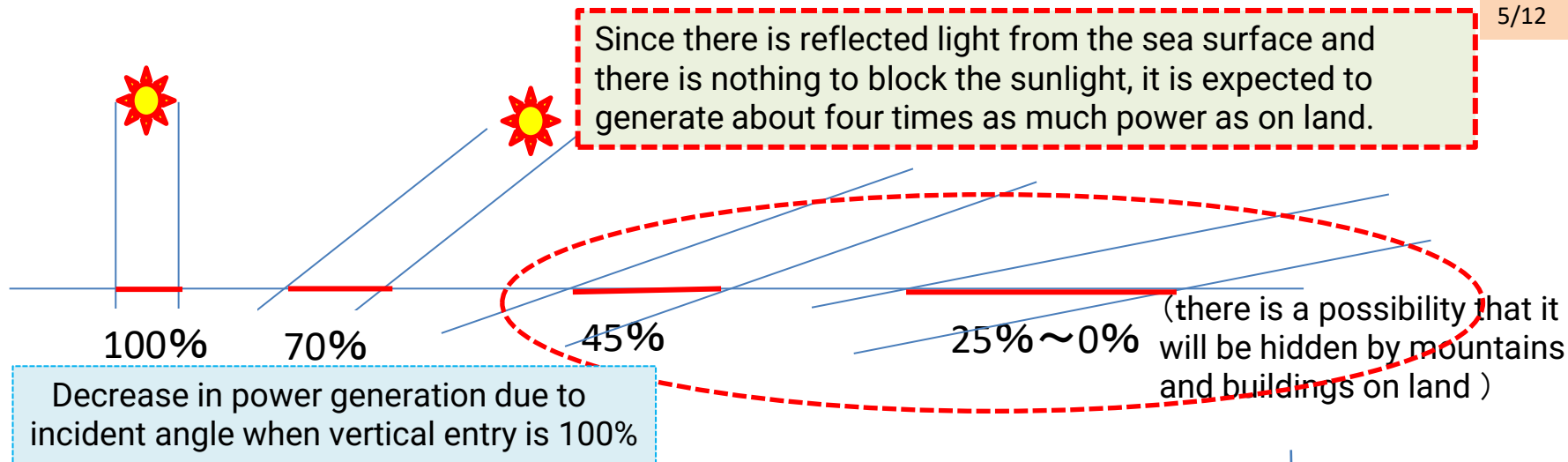

The basic unit of the wooden artificial island is \square 12m, and the medium unit made by wooden rivets and glue: \square 12m is defined as 10 x 10 pieces (= \square 120m).

When 3x3 medium units are arranged, 12 water turbines ($3 \times 120 / 30 =$) of less than 30m are arranged in two rows (24 units), arranged in horizontal and vertical channels, (interference between vertical and horizontal), we believe it is possible to install about 40 tidal current generators. In addition, assuming that one tree-type solar power generation system is installed in the basic unit (square 12m), about 80 units can be installed in the empty space for installing tidal current generators in the middle unit, and about $80 \times 3 \times 3 = 720$ units can be installed. become.

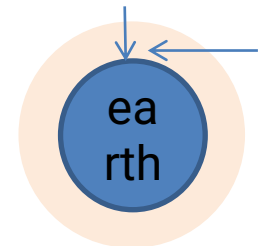

It can be used until the last minute of sunrise and sunset.

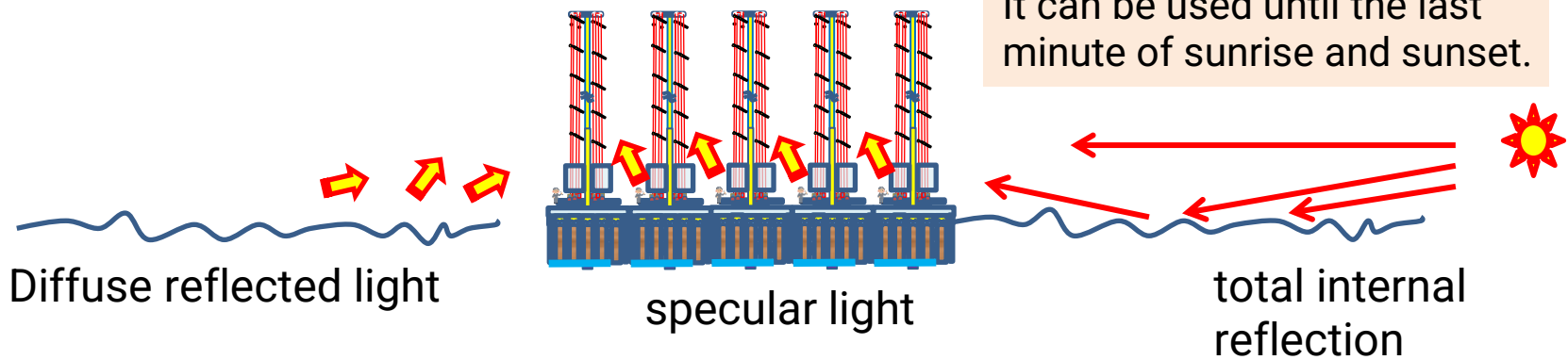

Place pillars at both ends and the center of the road, set angles, and install a tree type on them (no civil engineering work required)

It would be better to install it in fields, vacant lots, parks, parking lots, etc., and coexist with the current living environment. (Installation in the mountains cannot be done by crane trucks, so it is necessary to start with road maintenance or assemble with a helicopter, which is expensive.)

I am proposing a self-driving car society at 6 km on the assumption that an accident will occur. Reservations can be made on smartphones 24 hours a day, more people are sleeping in the middle of the night, the number of cars during commuting hours has been halved, and roads can be made narrower than before, making it possible to grow organic vegetables in busy streets

Since it is sufficient to just hang it, various facilities such as plastic greenhouses and tents can be installed on the lower side at low cost.

Neighborhood association vegetable garden mainly for lunch

Assuming that exhaust gas will not be emitted due to the shift to EVs and FCVs, we will create a kitchen garden space managed by an organic farming neighborhood association that can also be shipped.

Put up an electric heating sheet and remove the snow

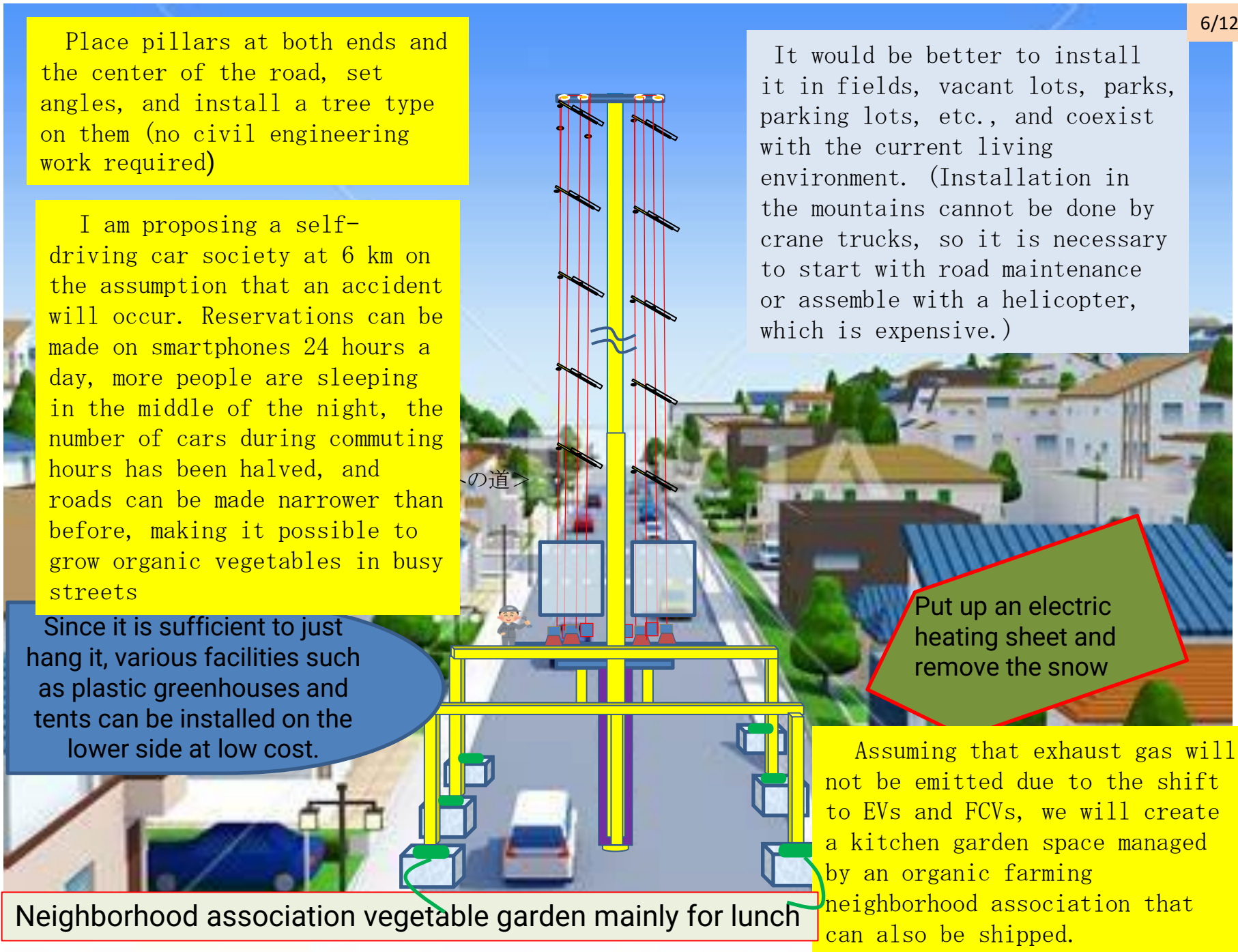

When installing a tree type on the mountainside on the south side (Assemble with a helicopter on the concrete base)

7/12

While mega-solar plants cause environmental destruction, tree-type plants have a stronger foundation and coexist with surrounding trees. Basically, it is installed on the mountainside on the south side, but it is necessary to set multiple viewpoints for each region and install them in places that are completely invisible from that point.

view point

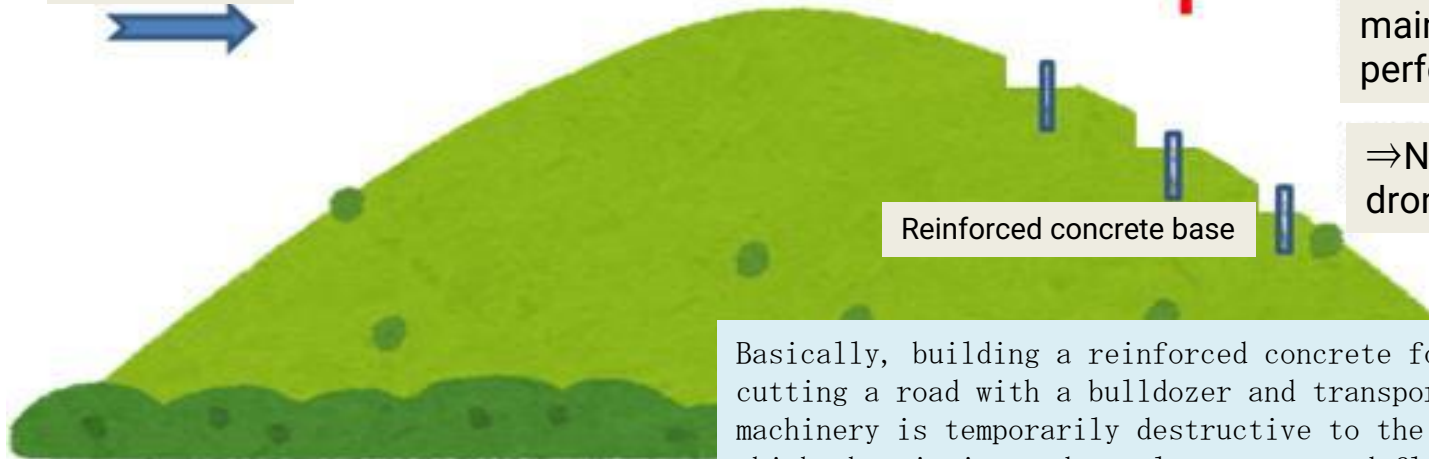

Reinforced concrete base

Transport and installation by helicopter

⇒Mount the maintenance cargo and perform fixing work.

⇒Neat work by spray drone

Basically, building a reinforced concrete foundation by cutting a road with a bulldozer and transporting heavy machinery is temporarily destructive to the environment. We think that it is good to plant trees and flowers and make it a walking path. (light trucks for maintenance pass)

For assembly, heavy parts are transported by helicopter, loaded as they are, and fixed work such as bolting is performed with the work cargo (lifted by the wire winding mechanism). Large-scale relocations and renewals every several decades are carried out by helicopter, painting and maintenance of several years are carried out by work cargo, and cleaning work of about three weeks is carried out by high-pressure washing drone autopilot. done. (Drones cannot be flown in residential areas, so a cleaning crew consisting of three people will perform the cleaning. Remote control operation, cleaning liquid application, and brushing)



maintenance cargo

Tree-type solar power generation system medium-sized standard type (33 m: 6 stages in front and back)

Draft standard specifications:
1m in diameter for the support shaft (tree), 33m in height (connecting 6 pieces of 5.5m), the size of the light receiving panel part is 9.9m x 1.65m; 30% for the front side and 0.1% for the back side.

Assuming an average household size of 32 square meters (5 kW: installation cost of approximately 4 million yen), the tree type will have a power generation capacity of 12.25 times, and the installation area will be 1/4. (Since the cost is about 12.5 times higher, the amount of power generated at the same cost is even.) is almost even at the same cost.)

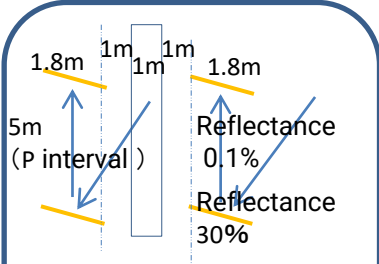

The light-receiving panel on the front side has a reflectance of 30% (half mirror) and the back side has a reflectance of 0.1% (anti-reflection coating) to increase power generation efficiency on the back side, which is less likely to reach high temperatures. Also, the best shift amount is automatically set according to the angle of the sun.

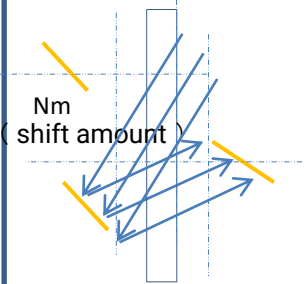

When the position of the sun becomes lower, the angle and shift amount of the solar panels are automatically determined so that the front reflected light from the second row of solar panels reaches the rear surface of the first row.

It is necessary to consider the solar tracking drive power, and it will be "about 10 times" in total.

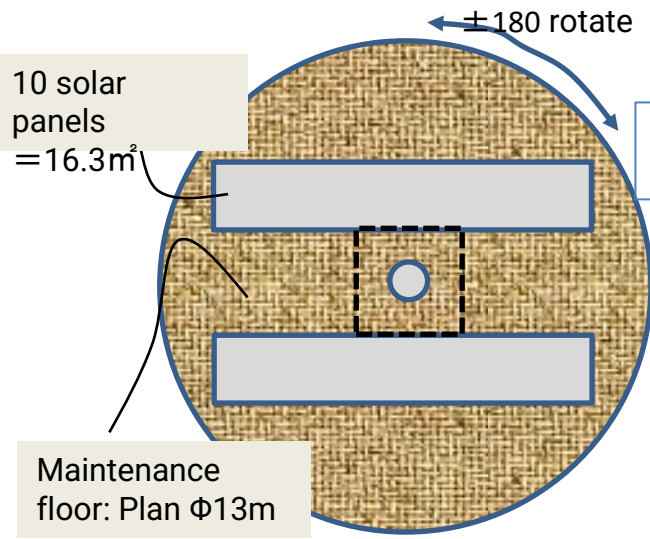

$$\frac{(2.8+13)}{2} \div 8$$
$$\frac{8}{32} = 1/4$$

Installation area 1/4

Called 40x for standard type

Base: □2.8m
Panel: 392 m²

Average area of solar panel for general household: 32m²

10 solar panels of 1.65m x 0.99m are arranged horizontally = 16.3m²
16.3 m x 2 (back side) x 2 (rows) x 6 stages = 392 m²
Installation cost of 392 m² is about 50 million yen

Household tree type solar power generation

Relatively high latitude local specifications such as Hokkaido and Ukraine: 3 to 5 houses

Wooden frame; weight reduction including panels. The corners are rounded to prevent injury in the unlikely event that the vehicle is blown away by the wind and hits someone.

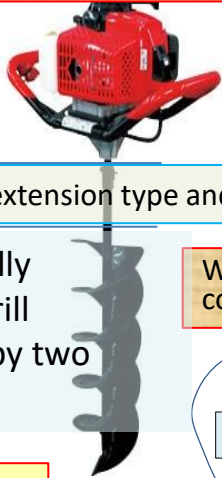

Prepare an extension type and replace

commercially available drill (operated by two people)

Dig a hole using the construction method introduced on the next page.

drop sand into the hole

Wooden holder with liquid glass coating and two bearings

Made of iron pipe

aluminium board

収納スペース (Storage space)

wooden

A smartphone app enables manual operation and is used during maintenance and cleaning.

electrical and internet wiring
Edge computer installation, etc.

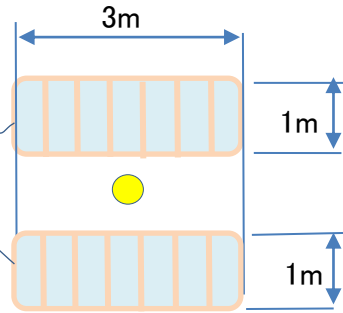

Effective panel area : 3m²

Resistant to snow, strong winds, sandstorms, earthquakes, no environmental damage

panel total area : 3m²x10=30m²

For small lot production (1/2 for mass production)

< COST : yen >

1. A : 40000
 2. B : 20000
 3. C : 60000
 4. D : 20000
 5. E : 400000
 6. F : 360000
 7. G : 100000
- TOTAL : 1000000

Separate panels, storage batteries, and converters

For 4 houses, per house: about 250000

A

B

C

D

E

F

G

Up to 20 m (using one one-touch relay unit), two people can pull up the wire part using non-slip gloves, so the work is completed in about 30 to 60 minutes.

A tool for building a water circulation system for each home

Fall prevention unit

pvc tube

1. Dig a hole, turn the dirt into muddy water, and pump it up.
2. If you hit a water vein, muddy water will not come out, so you mainly use the wire part to pull it up.
3. Drop the PVC tube while instantly bonding it

water vein connection

The top and bottom are interlocked, repeating friction & fall prevention and full release.

muddy water suction pipe

muddy water intake

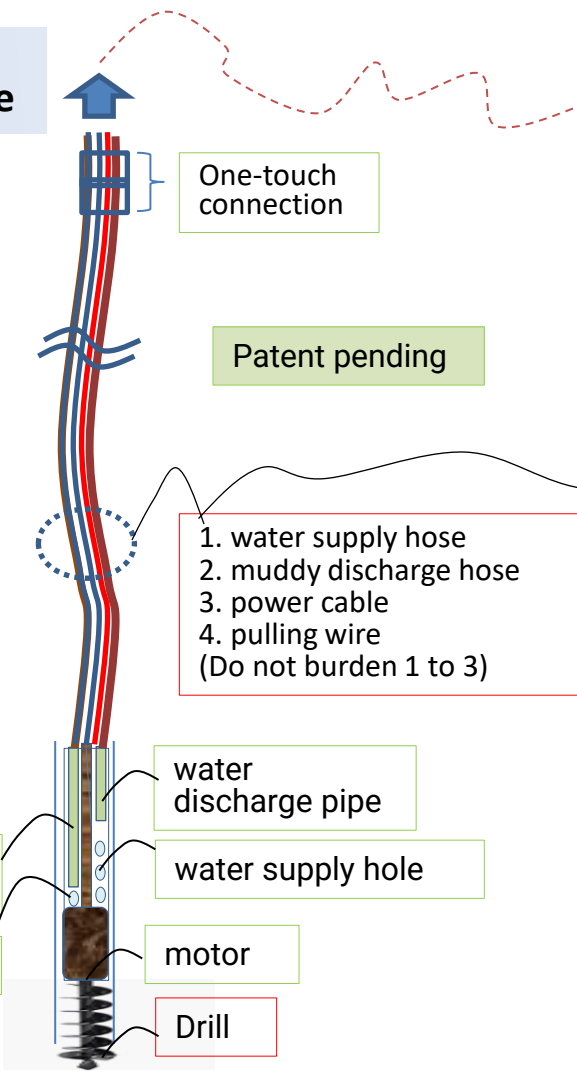

One-touch connection

Patent pending

1. water supply hose
2. muddy discharge hose
3. power cable
4. pulling wire (Do not burden 1 to 3)

water discharge pipe

water supply hole

motor

Drill

1. exhalation pump
2. suction pump
3. take-up motor
4. Power supply

male mold

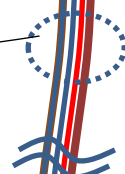

For small lot: production (1/3 for mass production)

<COST: yen>

8: H:	500000
9: I:	200000
10: J:	5000000
TOTAL:	5700000

one touch relay unit (10m)

Price of thin (2mm·3m²) solar panel: 500,000

female mold

H

I

J

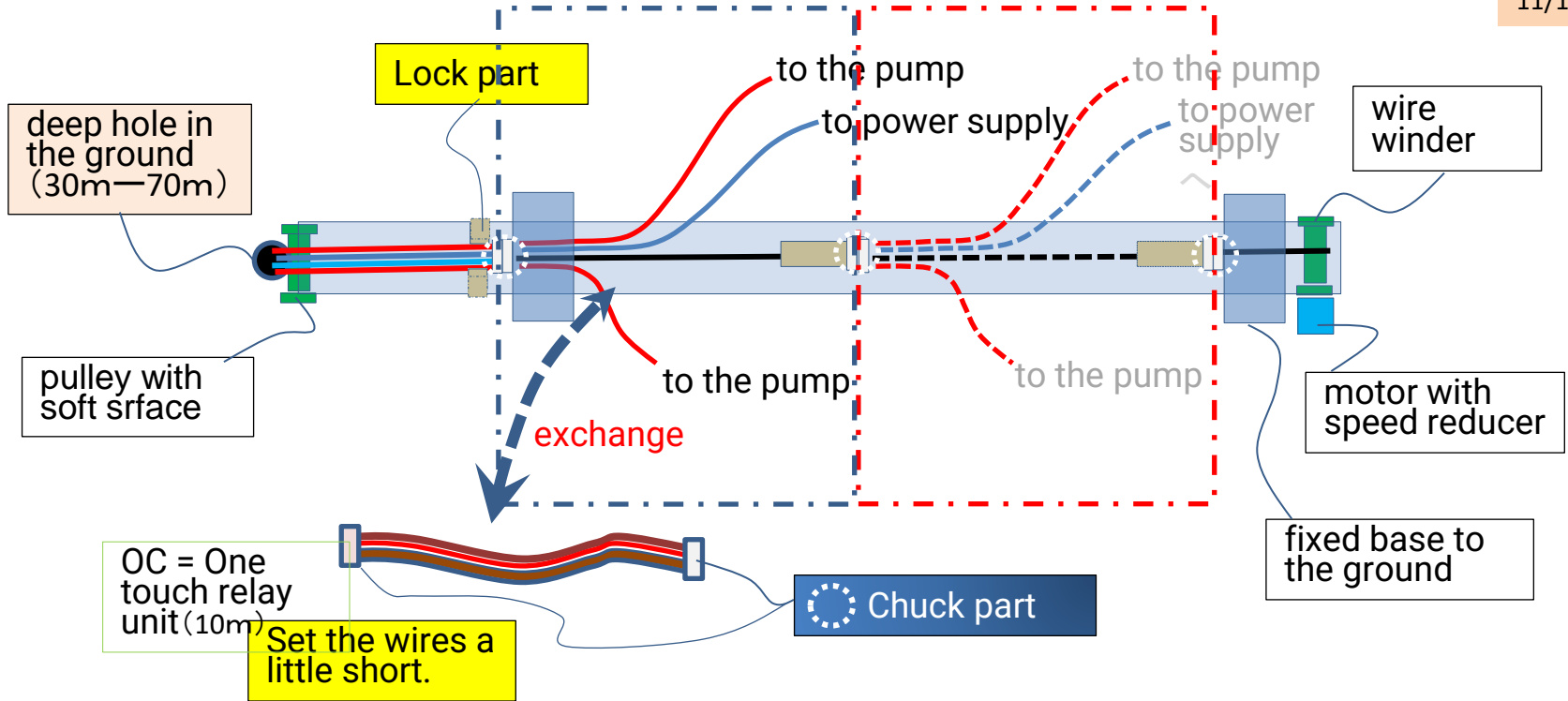

Drilling process: As the drill moves deeper into the hole, the motor slowly unwinds. When the OC shifts to the left little by little and the chuck on the right side of the OC touches the lock, the drill stops, the drilling stops, the worker removes the chuck, and then the wire is wound. (Wind up to the position of the red dashed line)

Attach the following OC and tighten the chucks on both ends. Release the lock, activate the drill, and resume digging. Also, when the lock is turned on, the right side chuck of the OC engages with the lock, stopping the drill.

Lifting process: Wind up with the motor to the position of the red dashed line, lock, rewind a little, unzip both ends of the OC, then remove the OC itself, then rewind the motor, and then the position of the blue dashed line. Move to and chuck the next OC unit. Unlock and rewind.

Ukraine Reconstruction Kit (Securing water and electricity first)

12/12

1. Create and verify prototypes in Japan (Crowdfunding or outsourcing to a private company (supported by patent revenue))

2. Send prototypes and drawings to a Polish company (your company). A Japanese engineer will go on a business trip to perform installation & TT.

3. Mass production at a Polish company (your company or your partner's factory)

4. Free installation in Ukraine (Jointly carried out by Polish and Ukrainian companies.)

5. A Ukrainian company will provide maintenance and regular cleaning.

The Ministry of Foreign Affairs of Ukraine, Poland, the EU, Japan, etc. will negotiate and determine the cost sharing. In the future, it will be manufactured in Japan and the EU as a whole, and spread all over the world...

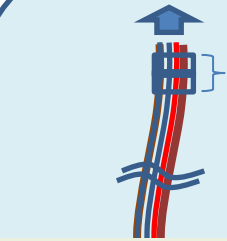

The excavated soil is stirred with water and sucked up as mud.

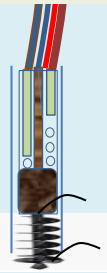

20m: ground hole digger (also applies to well digging) Small lot 700000yen
Cost 1/3 in large lots

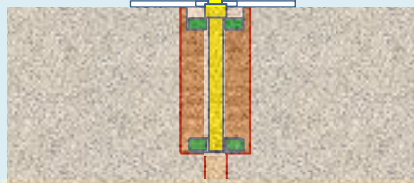
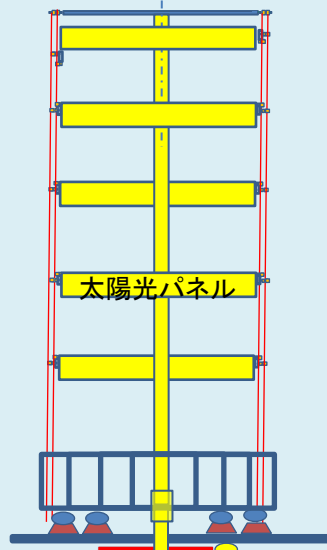

3 to 5 houses, tree type solar power generation system for home use
Small lot: 6000000yen (2m: 10 panels x 500000yen = 5000000yen)
Cost 1/2 for large lots

Please refer to P9 and P10 of "Tree type solar power generation system" on the website

Prototypes will be made in Japan, information will be sent to Polish companies, and mass production will be carried out at the factory of Polish companies.